

APOLLO 8000
METERING TYPE (BELT)
SPREADER CONTROL

Operation

RDS Part.No.:	S/DC/500-10-315
Doc. Issue:	1 : 20/9/01
Software Issue:	PS516-000 rev.30

Electromagnetic Compatibility (EMC)



This product complies with Council Directive 89/336/EEC when installed and used in accordance with the relevant instructions.

IMPORTANT, READ THIS BEFORE USING THE APOLLO

The *Apollo* installation is a part of the Precision Farming System ("the System"). It is very important that you follow the described calibration procedures before operating the *Apollo* instrument. Calibration and operation of the *Apollo* must be in accordance with these instructions. Use of the System is subject to the following disclaimer;

1. So far as is legally permissible RDS Technology ("RDS"), or its distributors, shall not be liable, whatever the cause, for any increased costs, loss of profits, business, contracts, income, or anticipate savings or for any special, indirect or inconsequential damage whatsoever (death or personal injury excluded).
2. The capabilities and functions of the Precision Farming System ("the System") are limited as set out in the specification of the System, details of which are contained in the Help files and product literature and which must be read before using the System.
3. Without prejudice to the generality of the above it is hereby acknowledged that the System is not designed nor intended to a) originate variable treatment plans or b) achieve or avoid any application rate outside application parameters, which in both cases shall be the responsibility of the operator.
4. The standard terms and conditions of RDS (except clause 7), a copy of which is available on request, apply to the supply and operation of this System.

Service and Technical Support

PLEASE CONTACT YOUR NEAREST DISTRIBUTOR

If unknown then fax: 44 (0) 1453 733311 for further information.

Our policy is one of continuous improvement and the information in this document is subject to change without notice.

Check that the software reference matches that displayed by the instrument.

© Copyright RDS Technology Ltd 2001

\UK315-1.DTP

CONTENTS

Section 1 Overview

1.1	The Pro-Series Head Unit	4
1.2	Installation and Inter-operability with other Systems	4
1.3	Control Software	4
1.4	Control Channels and "Tanks"	5
1.5	Control Modes	5
1.6	The Operating screens	7
1.6.1	Menu keys - 7	
1.6.2	The MAIN screen page (single belt operation) - 7	
1.6.3	Status Indicators - 8	
1.6.4	The MAIN screen page (multiple - belt operation) - 9	
1.6.5	The INFO screen page - 10	
1.6.6	The LOG screen page - 10	
1.6.7	The SETUP screen page - 11	
1.6.8	Data Entry - 11	
1.6.9	Units - 12	

Section 2 Operation

2.1	Startup	13
2.2	Product Selection.	13
2.2.1	Editing Product Names - 13	
2.2.2	Programming the Product Density - 14	
2.3	Daily Calibration.	15
2.4	Automatic Rate Control.	16
2.4.1	Setting the Target Rate - 16	
2.4.2	Overriding the Target rate - 16	
2.5	Manual Rate Control.	16
2.5.1	Output Indicator - 17	
2.6	MAIN Screen Display Options	17
2.7	Hopper Contents.....	17
2.7.1	Hopper Level Alarm - 17	
2.7.2	Programming the hopper contents - 18	
2.8	Part / Total Registers and RPM Display.....	19
2.10.1	Reset Totals - 19	

Section 3 Logging Options

3.1	Hardware Setup.	20
3.2	Variable Rate Treatment	21
3.2.1	Running a variable rate treatment plan - 21	
3.2.2	Overriding the VRT Application Rate - 22	
3.2.3	Stopping a VRT Job - 22	
3.2.4	Tagging - 23	
3.2.5	Extended Data Functions - 23	
3.2.6	Display Vehicle Track - "MAP" - 24	
3.2.7	Display GPS Status - 24	
3.3	Dynamic Data Logging	25
3.4	Field Data Logging.	26
3.5	Review, Reset or Download a Job Summary.	27

1 Overview

This manual covers the operation of the Pro-Series 8000 when configured for variable rate control of belt spreaders. Separate manuals are supplied for variable rate control of disc spreaders.

1.1 The Pro-Series Head Unit

The RDS PS 8000 is a fully DGPS compatible, multi-function cab computer for a wide range of applications and is the central component of RDS Precision Farming hardware (figure 1).

Figure 1

The Pro-Series 8000 is the central component of RDS Precision Farming hardware

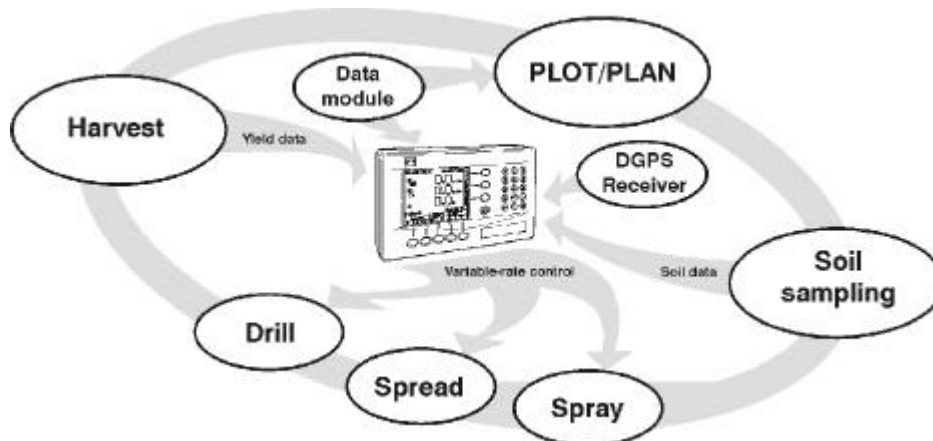

1.2 Installation and Inter-operability with other systems

An RDS control system comprises several component kits. This modular approach means that a suitable control system can be specified for a very wide range of implements. When re-configured with the appropriate control software the PS 8000 head unit can be simply transferred between different implements.

The PS 8000 can also output variable-rate instructions to other control systems including Vicon, Bogballe and Amatron systems, as well as acting on variable-rate instructions received from Fieldstar, SoyI Opti, Agrocom ACT and Hydro-N Sensor systems.

1.3 Control Software

Your instrument is supplied pre-loaded with the appropriate control software (in this instance for rate control of belt spreaders :- software type PS516-xxx).

With the purchase of a "secondary software module" - an electronic chip loaded into the back of the instrument, the Pro-Series can be instantly switched to perform another function e.g. from a Spreader Controller to a Data Logger for route navigation and soil mapping tasks. This is done from "Instrument Select" in the "USER OPTIONS" menu.

There are software modules for yield monitoring/mapping, route/soil mapping, variable-rate sprayer control, variable-rate belt spreader control, variable-rate disc spreader control, and variable-rate seed drilling.

For information on connecting and configuring RDS PF hardware e.g. the Data Card Module, Secondary Software Module, DGPS Receiver, cables etc, and data transfer to your PC, please refer to the "Precision Farming Supplement".

1.4 Control Channels and 'Tanks'

The Apollo 8000 is an extremely versatile control system with 4 separate control channels. To enable spreading more than one product at the same time, the instrument can simultaneously control up to three metering systems each comprising a motor/proportional hydraulic valve and flow rate sensor (rotary encoder), albeit through a single distribution system (i.e. wiring loom and junction box). The fourth channel cannot be used for driving a motor/valve.

A 'tank' is the default description for each channel (you can programme your own description accordingly).

Single belt operation

By default, only 'tank 1' (channel 1) is enabled, for controlling a belt spreader with a single belt.

Multiple belt operation



Some belt spreaders have more than one metering system/hopper for simultaneously spreading more than one type of product, or for spreading independently to the left and right.

Additional 'tanks' are enabled from the 'Machine Options' screen in the calibration menu. The MAIN menu key is then used to cycle between the separate "tank" display screens and also a screen displaying application rates for all 'tanks'.

NOTE: This manual predominantly covers single belt operation.

The  symbol indicates additional information specifically pertaining to multi-tank operation.

1.5 Control Modes

The *Apollo 8000* has three control modes;

Manual Control Mode

This gives simple manual control of application rate. Field data ("job memos") can be logged and stored in the instrument memory. Up to 75 summaries can be stored.

Automatic Control Mode

This gives fully automatic rate control regardless of forward speed. The material flow rate is automatically regulated as forward speed varies, to ensure that the actual application rate constantly matches a preset target rate. The application rate can be manually nudged up and down from the target rate as required for spot application in specific areas.

Field data ("job summaries") can be logged and are stored in the instrument memory. Up to 75 summaries can be stored. If you have a GPS receiver and RDS Data Card Module connected, as well as creating a job summary, you can also log the vehicle route and application data to a "dynamic log" file on the PCMCIA card. The job summary data is also appended to this file, which can be viewed in PLOT/PLAN.

VRT (Variable-rate treatment) Control Mode

This enables the system to be controlled via treatment instructions prepared using RDS PLOT/PLAN or similarly capable Precision Farming software programs, in conjunction with DGPS position data. To enable fully automatic variable-rate treatment for Precision Farming applications, the *Pro-Series 8000* requires a suitable DGPS receiver and the RDS PCMCIA Card Module to implement treatment plans generated in RDS PLOT/PLAN. The card module also logs data confirming the actual treatment.

A work record file is automatically created on the card module to log data confirming the actual treatment. The job summary data is also appended to this file, which can be viewed in PLOT/PLAN.

Please refer to the 'Precision Farming Supplement' (Pt. No S/DC/500-10-202) for details of DGPS installation, setup and data transfer with the Data Card Module.

1.6 The Operating Screens

1.6.1 Menu keys

All instrument functions are accessed by nine menu keys adjacent to the LCD display.

Figure 2

The functions are controlled via the menu keys next to the display

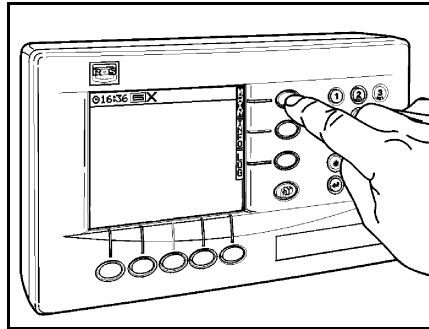

The four menu keys to the right of the screen (figure 2) access the primary screen pages (those viewed during normal operation). There are three primary screens MAIN, INFO and LOG for normal operating functions, and a SETUP screen for calibration functions and other settings.

The five sub-menu keys below the screen control the various display functions and settings for each of the primary screen pages. Text or icons are displayed adjacent to the sub-menu keys to denote their function.

1.6.2 The MAIN screen page (single belt operation)

The instrument will always default to the MAIN screen on startup. The MAIN screen displays the following information (figure 3).

Figure 3

The information displayed on the MAIN screen

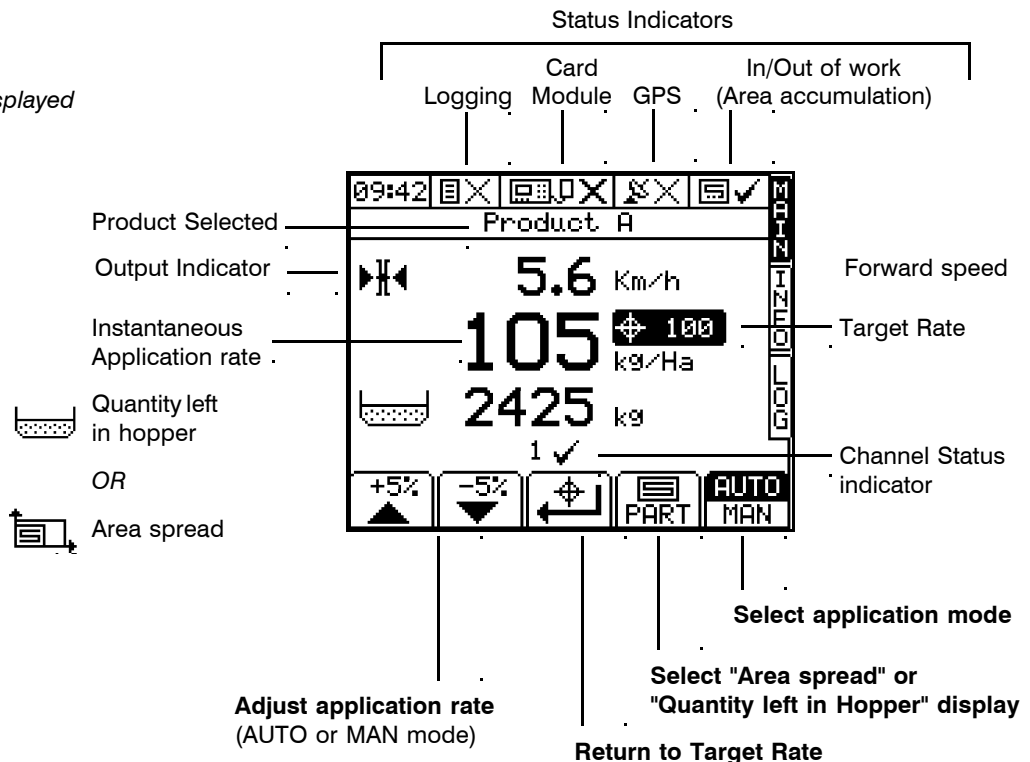

1.6.3 Status Indicators

The row of icons at the top of the page show the following;

(i) if logging is in progress or not :-



Logging stopped



Logging started

(ii) if the Card Module is connected and whether a card is inserted:-



No Module



Module but no card



OK

(iii) if a GPS signal is being received:-



No Position



Standalone (No Diff.)



Full DGPS

(iv) if the area / distance is being accumulated:-



No accumulation



Accumulation

NOTE: The GPS icon and the Data module status icons will only appear if the GPS / Data Module settings are selected in the "PORTS SETUP" menu (refer to the calibration manual).

Otherwise, the status indicators will appear on all the screen pages



1.6.4

The MAIN screen page (multiple belt operation)

The instrument will always default to the MAIN screen on startup. The MAIN screen differs from that for single tank operation only in the respect of there being a separate screen page for each channel enabled (fig. 4), and also a screen page which shows the application rates for all tanks - the "multiple tank" page (fig. 5).

The channel status indicators shows which channels are in work.

Single tank display and settings

Press the MAIN menu key repeatedly to cycle between each MAIN screen page.

You can set the target rate, application mode (AUTO or MAN) and alter the actual application rate for each tank independently by selecting the screen page for the appropriate tank.

Figure 4

The MAIN screen page with multiple 'tanks' enabled

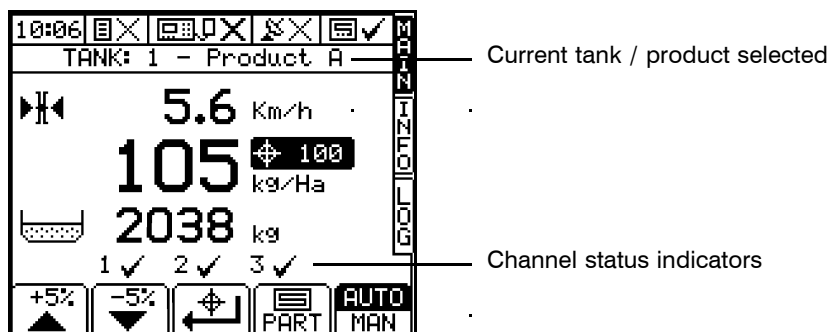
**Multiple-tank display and settings**

Alternatively, you can alter the application rate simultaneously for all tanks set for AUTO, from the "multiple tank" page (fig. 5) by pressing the arrow keys. All rates will change by the same percentage.

Figure 5

The "multiple tank" MAIN screen page.

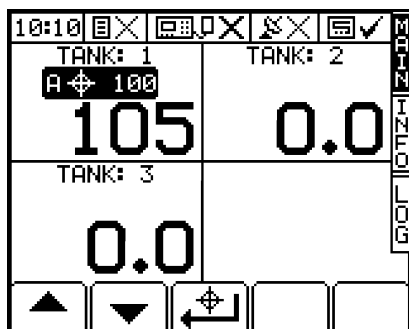

The target rate from each tank is displayed by the  graphic. If the application rate from an individual tank has been adjusted above or below the target rate, then that target rate will be flashing on the "multi-tank" page. Note that in this example, "Tank 2" and "Tank 3" do not show a target rate because the application rate for those tanks are set to MAN mode.

Pressing the  key will reset all tank rates to their respective pre-programmed target rates.

1.6.5 The INFO screen page

Additional work measurement functions are displayed on this page. If only one tank is enabled, the screen will display only the product selected and not the tank number as shown in figure 4.



NOTE: *If more than one tank is enabled there is a separate screen page for each tank (as for the MAIN screen). Press the INFO menu key repeatedly to cycle between each page.*

Figure 6

The information displayed on the INFO screen

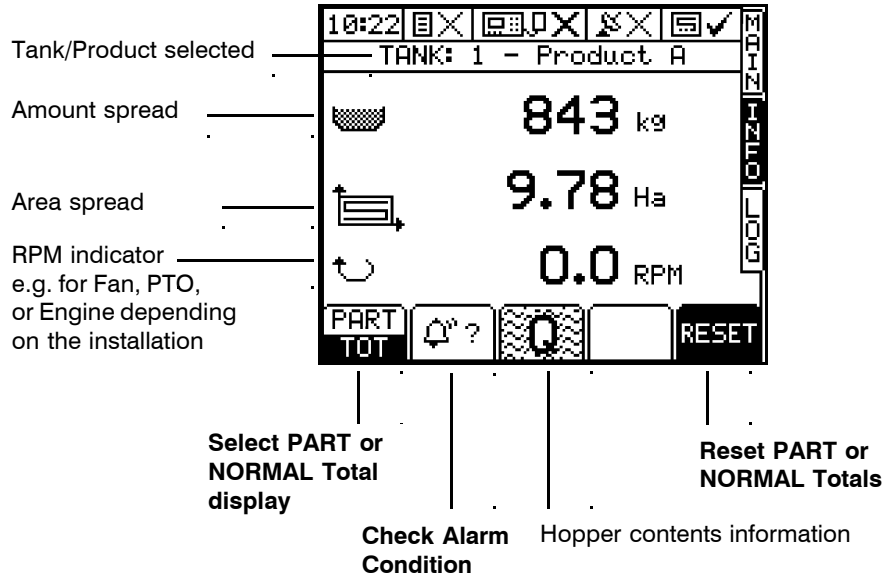

1.6.6 The LOG screen page

This page controls data logging (Field Summary data), P.F. functions (when the Data Card Module is connected and enabled), and data transfer (e.g. printing a job summary).

Figure 7

The information displayed on the LOG screen

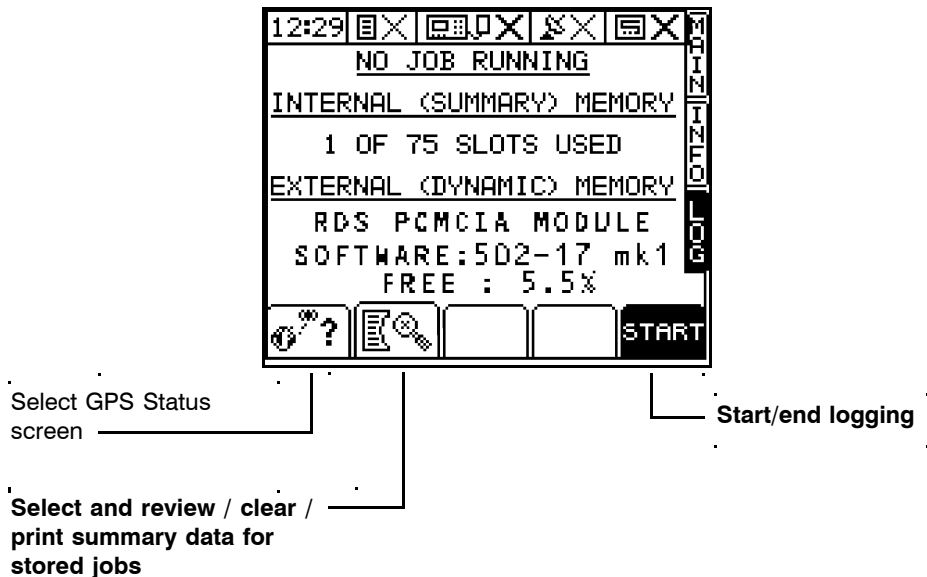

1.6.7 The SETUP screen page

The  key selects the SETUP menu for calibration purposes and other instrument settings including those specific to particular products being applied.

Figure 8

The information displayed on the SETUP screen



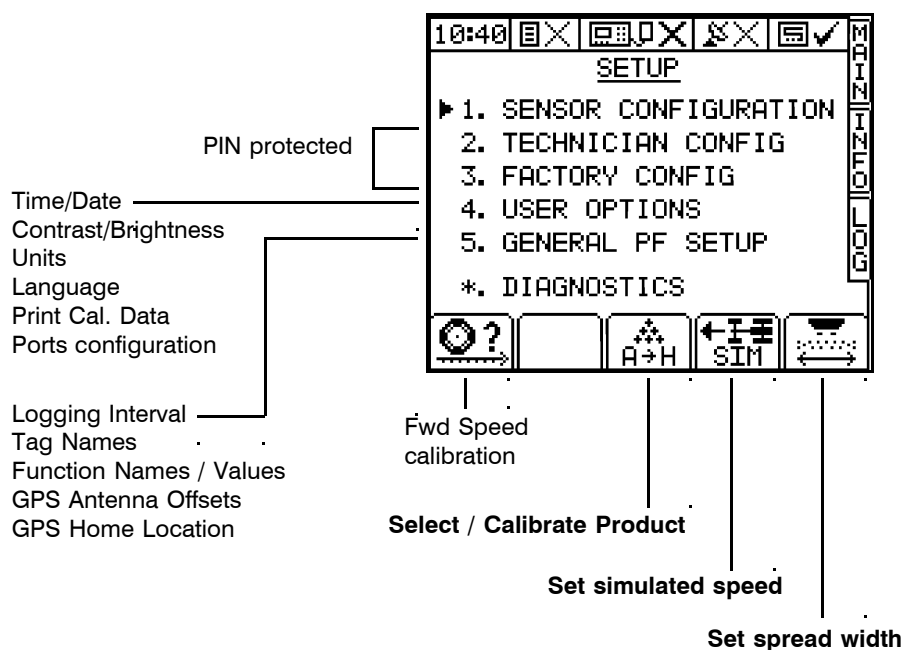

You should not need to enter menus 1, 2 and 3 in normal use. These settings are generally made only on initial installation. Menus 2 and 3 can be protected with a personalised PIN number to prevent unauthorized access.

1.6.8 Data Entry

Alpha-numeric values are entered via the right-hand keypad. You must press the key from 2 to 5 times to select the required letter. (Some keys have additional special characters not shown on the key legend).

The  key will either toggle between lower and upper case characters or when preceding a numerical entry, will set a MINUS value.

The  key will toggle between 0 and a SPACE.

The  key will BACKSPACE the screen cursor if you need to re-enter a character.

The  key is the RETURN key and is normally pressed to confirm the data entry into memory.

1.6.9 Units

Information can be displayed in Metric or Imperial units by selecting the desired option via the SETUP menu. Please refer to the Calibration manual.

The "UNITS" menu gives 5 choices,

Km / Ha	/ L	/ kg	(default)
Km / Ha	/ m ³	/ tonnes	
Mile / Acre	/ Gal	/ lb	
Mile / Acre	/ kgal	/ tons	
Mile / Acre	/ US gal	/ lb	

For spreading, the units are:-



Function	Units	
	Metric	Imperial
Forward Speed	k m/hr	miles/hr
Application rate	kgs or tonnes/ha	lbs or tons/acre
Part/Total Area	hectares	acres
Part/Total volume spread	kgs or tonnes	lbs or tons

2 Operation

2.1 Startup

Press the  key. The startup screen, which shows the software version, will display for about 8 seconds then the MAIN screen is displayed.

2.2 Product selection

- 1 Press the  key and then press the  key (figure 9).

The 'PRODUCT SELECTION' screen only lists tanks that have been enabled via the calibration menu.

 **NOTE 1:** By default, the tanks are labelled "Tank 1" to "Tank 3" however, these descriptions may be edited via the "MACHINE OPTIONS" page in the calibration menu.

- 2 Select the tank using the left / right arrow key, then using the up / down arrow key, move the screen cursor opposite the product for that tank (figure 9b). For any tank, you can programme and calibrate up to 8 different products "A" to "H".



 **NOTE 2:** By default, the products are labelled "A" for tank 1, "B" for tank 2 and "C" for tank 3. You can edit the product description by pressing the  key while the "PRODUCT SELECTION" screen is displayed (section 2.2.1).

Figure 9
Selecting the *PRODUCT SELECTION* screen

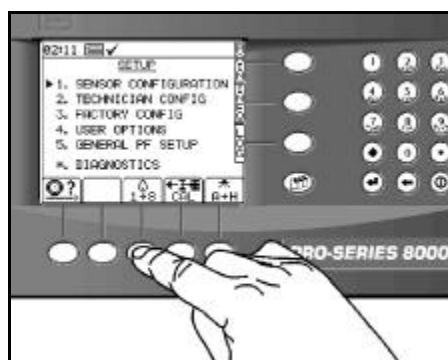

Fig. 9a

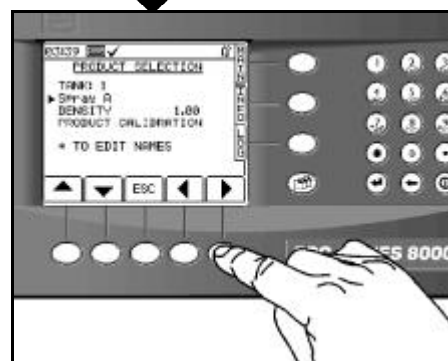



Fig. 9b

- 3 Press the MAIN key to return to the "MAIN" screen page.

2.2.1 Editing Product Names

The 8 default product descriptions are "Product A" to "Product H".

- 1 From the 'PRODUCT SELECTION' screen, press the  key to select the 'PRODUCT NAMES' screen.
- 2 Select the product name from the list using the up / down arrow keys, and edit the name using the alpha-numeric keypad.
- 3 Press the MAIN key to return to the "MAIN" screen page.



2.2.2 Programming the Product Density

The system is calibrated by *volume* of product (litres / rev) whereas the application rate is by *weight* of product per unit of area. It is therefore important to programme the density of the product to be applied.

If the density is not programmed correctly, the application rate displayed will be different from that applied.

Whenever the programmed density is greater than 1.00, the instrument will display the  icon on the main screen.

To set the product density;

- 1 Press the  key and then press the  key to display the "PRODUCT SELECTION" screen (fig. 9a, 9b).
2. Select the DENSITY line, key-in the correct density (kg/litre) and press ENTER.
3. Press the "ESC" key or press  to return to the SETUP screen, (or press the MAIN key to return to the operating screen).

NOTE: *The units for density depend on the units you have selected in the calibration menu e.g. they will be either kg/litre, tonnes/cubic metre, lbs/gallon etc.*

It is important to set the product density before performing product calibration.

2.3 Daily calibration

It is recommended that you calibrate regularly, particularly when you change the product.



If you are controlling more than one channel (i.e. more than one product is being spread) then you must calibrate separately for each channel in turn.

If you are going to spread a product for the first time you need to establish an initial calibration factor for that product. What you must establish is the volume of product dispensed per revolution of the metering shaft encoder. Refer to the calibration manual for initial product calibration.

If you are spreading a product for which you have already established the calibration factor, and you find a discrepancy between the amount actually dispensed from the hopper and the instrument reading, you can simply NUDGE the calibration as follows:-

Nudging the Calibration Factor

Example:- You know you have spread a full load of 3 tonnes but the instrument displays 2.7 tonnes spread.

1 Select the CAL NUDGE screen :-



- (i) From the SETUP screen, press  to select the PRODUCT SELECTION screen.
- (ii) Select the line "PRODUCT CALIBRATION" and press ENTER.
- (iii) Press "3" to select the CAL NUDGE screen (fig. 10).

Figure 10
The CAL NUDGE screen

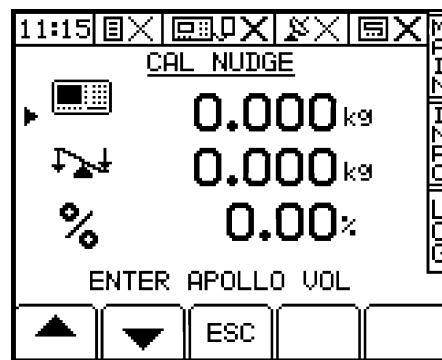

2. Enter the instrument reading (), the actual weight spread () and press ENTER. The calibration factor will then automatically be adjusted for the selected product.

NOTE: If you alter the gate setting on the spreader, you must re-calibrate.

2.4 Automatic Rate Control



Press the MAIN menu key to cycle to the desired tank.

Select 'AUTO' from the 'MAIN' screen. The belt speed will be automatically adjusted as forward speed varies, to ensure that the actual application rate constantly matches the preset target rate. You can also log and store field data ("job memos") as you go, and print out job summaries or transfer data to a PC when convenient (refer to section 3.4).



2.4.1 Setting the Target rate



Press the MAIN menu key to cycle to the desired tank.

From the "MAIN" screen simply key-in the desired target rate and press .

2.4.2 Overriding the Target rate

Press   to override the target rate.

The preset target rate can be over-ridden in percentage steps (default $\pm 5\%$ steps) while spreading, e.g. for localised soil conditions.

NOTE: you can change the step size in from the calibration menu.

While over-ridden, the target rate indicator  will flash.

Press  to return to the target rate.

If the instrument alarms it will beep once, default to the alarm screen and indicate the alarm condition e.g. "Hopper Level Low", "Under Application", "Over Application" etc.



Press any of the lower 'OK' keys to cancel the alarm screen and return to the 'MAIN' operating screen.

2.5 Manual Rate Control



Press the MAIN menu key to cycle to the desired tank.

Select 'MAN' from the 'MAIN' screen. To maintain the required application rate, you must maintain a constant forward speed. You can also log and store field data ("job memos") as you go, and print out job summaries or transfer data to a PC when convenient.

Press   to adjust the application rate.

2.5.1 Output indicator

On a metering type spreader this icon relates to the speed of the hydraulic/electric motor driving the metering belt. This indicates approximately the spreader output relative to its maximum output.



Minimum output



Medium output



Maximum output

2.6 "MAIN" screen display options

In addition to the Application rate and Forward Speed display, on the appropriate MAIN screen page for each machine enabled, you can select between,



Volume remaining in hopper ( kg, tonnes, tons or lbs)



Accumulated area ( hectares or acres)

Figure 11
Selecting the display option
on the MAIN screen

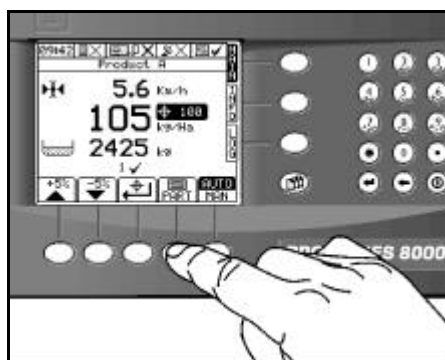

2.7 Tank Contents

2.7.1 Hopper Level Alarm

The *Apollo 8000* automatically calculates the volume of product remaining in the appropriate hopper. The calculation is based on the full hopper volume which is programmed via the "INFO" screen. You can also programme an alarm threshold so that the instrument will warn you when the hopper volume is getting low.

NOTE 1: *If you have a hopper level sensor or sensors fitted on your machine, the instrument will alarm "HOPPER LEVEL LOW" independently of the alarm threshold programmed on the instrument.*

When the alarm threshold is reached (e.g. 100 kgs), first of all the screen will change to show the alarm screen and the message '**TANK # LOW**'. The instrument will beep once. Press any of the lower 'OK' keys to cancel the alarm screen and return to the 'MAIN' operating screen. The screen will change to show the alarm screen and the message '**TANK # EMPTY**' once the tank contents register reaches zero. Again, press any of the lower 'OK' keys to cancel the alarm screen and return to the 'MAIN' operating screen. The tank contents register must be reset manually after refilling the hopper.

NOTE 2: *"TANK" is the default description in screen messages. You can however programme your own description from the "MACHINE OPTIONS" screen in the calibration menu.*

2.7.2 Programming the hopper contents

1 Select the "INFO" screen.

NOTE: Press the INFO menu key to cycle to the appropriate "tank". This is displayed at the top of the screen in the default format "TANK # - PRODUCT" or your own programmed description.

2 Press  to access the hopper contents screen (fig. 12)

The screen will display,

- "MAX" - the hopper capacity
- "NOW" - the quantity calculated to be remaining in the hopper
- "TO ADD" - the quantity to re-fill the hopper
- "RESET TO FULL" - the quantity left when the alarm is activated.

Figure 12
Resetting the Hopper Volume

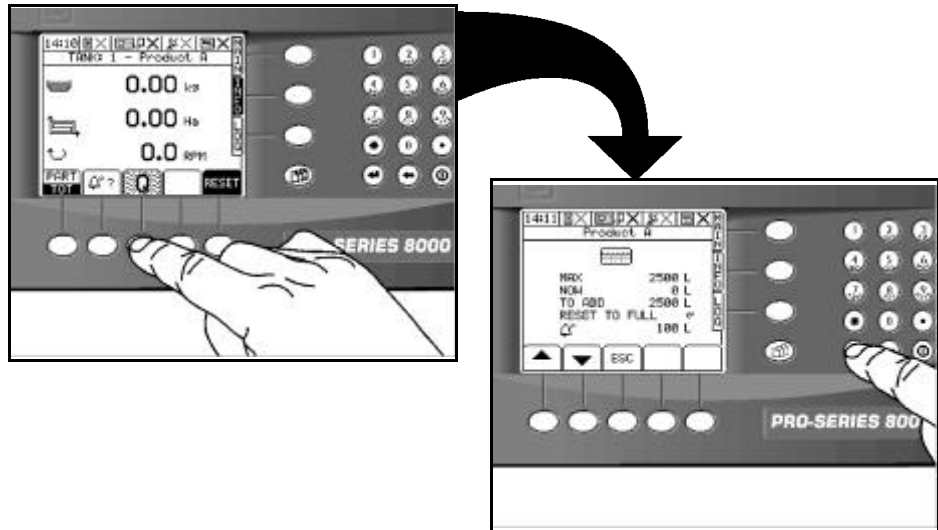

NOTE: Move the screen cursor using the arrow keys and enter values via the numeric keypad.

- 3 Confirm that "MAX" corresponds to the capacity of the hopper. Adjust as necessary.
- 4 Replenish the hopper and increase the "NOW" volume by the amount added (or if filling the hopper to full capacity, select "RESET TO FULL" and press ENTER). The "TOO ADD" readout will be re-calculated automatically and for a full hopper should read zero.
- 5 Confirm the alarm quantity () is OK (typically the amount needed to spread a single bout). Adjust as necessary.

2.8 Part / Total Accumulation and RPM display

You can record the area and weight spread for a particular job using the "PART" Total function. In addition the area and weight will be recorded to the "TOTAL" memory register.

- 1 Select the "INFO" screen to display the accumulated totals and the RPM display.



NOTE:

If more than one tank is enabled, there is a separate screen page for each tank (as for the MAIN screen). Press the INFO menu key repeatedly to cycle between each page.



- 2 Select 'PART' to display the Part Area and Part Weight accumulation,



Select "TOTAL" to display the Total Area and Total Weight accumulation.

2.8.1 Reset Totals

- 1 Select the "PART" or "TOTAL" display.
- 2 Press the **RESET** key.
- 3 Press  to zero the totals or press **ESC** to return to the "INFO" screen.

3 Logging Options

The Pro-Series has a separate LOG screen. Data is logged to internal (summary) memory and/or external (dynamic) memory (fig. 13) depending on the logging option. You can choose from three logging options. They are;

(i) **APPLY FROM PLAN (Variable-Rate Treatment)**

A variable-rate (or fixed-rate) treatment plan is imported from the RDS Data Card Module, allowing the operator to commence a full VRT application. An application record of the *actual* application is generated and saved on the Data Module. The associated work record file can be viewed in PLOT/PLAN. Job summary data (iii) is also appended to the work record file.

(ii) **LOG TREATMENT (Dynamic Data Logging)**

An application record is generated, logging rate and other parameters (e.g. "tags") in real time, attributing this data to a specific location. The associated "Dynamic Logging" file is viewed in PLOT/PLAN. A large amount of data is generated by dynamic logging and therefore must be saved onto an RDS Data Card Module. Job summary data (iii) is also appended to the dynamic logging file.

(iii) **LOG SUMMARY ONLY (Field Data Logging)**

For farm record keeping and traceability purposes, you can record a summary of each job or work session in the internal memory, and subsequently download directly to a PC, or print to an RDS ICP200 In-Cab Printer. The amount of summary data for each job is small, and it is saved in the internal memory. The instrument can store up to 75 individual job summaries. Options (i) and (ii) also require a GPS receiver to be connected.

Figure 13
The LOG page



3.1 Hardware Setup

Connect the PCMCIA Card Module to the **top** serial port on the rear of the instrument, and connect the DGPS receiver to the **bottom** port. The PS8000 must be configured to recognise the Data Module and GPS Input (refer to the calibration manual). For information on connecting and configuring RDS PF *hardware* e.g. the Data Card Module, Secondary Software Module, DGPS Receiver, cables etc, and data transfer to your PC, please refer to the "Precision Farming Supplement".

NOTE: **Mark I Data Modules:** If you have a Mark I Data Module, always power it off before inserting or removing a PCMCIA card, otherwise you risk corrupting data stored on the card.

Mark II Data Modules: Mark II modules are only powered up when a PCMCIA card is inserted. If there is no card in the module when it is connected to the instrument, the module will not be detected. The PCMCIA card can be inserted or removed without any risk of corrupting stored data. The module type, software, and free space is identified on the LOG screen when the module is detected.

3.2 Variable Rate Treatment (VRT)

An RDS Data Card Module and a GPS receiver must be connected.

3.2.1 Running a Variable Rate Treatment plan

- 1 Press the LOG key.



The screen will display the current logging status, the number of jobs (job summaries) stored in memory, and the status of the PCMCIA card if found (fig. 14). If the module is not detected the message "NO MODULE FOUND" is displayed. When successfully connected, the  icon appears at the top of the screen.

- 2 Press the START key. The JOB STARTUP page is displayed.

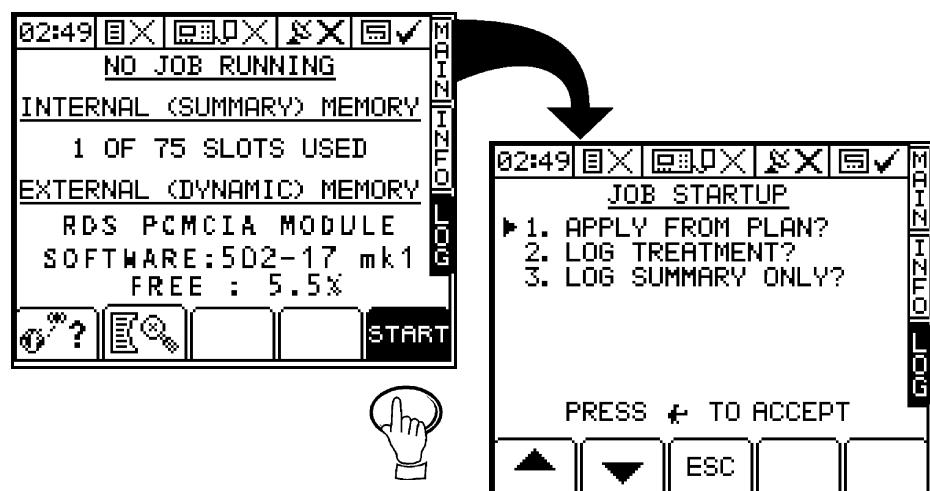

Figure 14
Select the JOB STARTUP page



- 3 Select the logging option "APPLY FROM PLAN".
- 4 If known, key in the FARM NUMBER and FIELD NUMBER of the treatment plan. If not, then press the LIST key, and the display will list all the farm / fields for which there are plan files on the datacard. Simply select the appropriate farm / field description in turn from the lists.

 **NOTE:** If a treatment plan is to be loaded and there is more than one "tank" (i.e. distribution system) enabled, the "SELECT MACHINE" page is now displayed. Scroll the cursor to the correct machine and press  to confirm.

- 5 SELECT THE APPROPRIATE PLAN and press .

 **NOTE:** If there is more than one "tank" enabled, the display will revert to the "SELECT MACHINE" page. If required, select another "tank", press , and then select a plan for that tank as in step 4 and 5 above.

- 6 Press the START key. The "EXTENDED DATA FUNCTIONS" page is displayed. If you don't wish to programme any extended functions, then press .

NOTE: If you want to programme extended functions, refer to section 3.2.5.

Wait while the work plan file is loaded and a work record file is created on the Data Module. Once the plan is loaded, the "RUNNING A PLANNED JOB" page appears, and displays the tag list (fig. 15). See section 3.2.4 about tagging.

Figure 15
Running a Treatment Plan



While VRT mode is in operation a flashing satellite symbol (fig. 16) is displayed alongside the Target Rate on the MAIN screen. The  icon appears with a tick at the top of the screen while logging is in progress.

Figure 16
Indication that variable-rate treatment is in progress



The target rate on the MAIN screen now becomes the application rate according to the treatment plan data (Base rate x Multiplier) and the position in the field. The treatment rectangle size is defined in PLOT/PLAN.

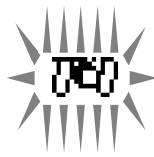

Plan Status Display

Press the  key to display the current application rate according to the treatment plan, for each distribution system in operation. This is displayed as "Base Rate x Multiplier = App. Rate"

Application Rate without a GPS Signal



If you lose the DGPS signal the treatment rate will revert to the "Base Rate" specified in the plan.

Application Rate Outside the Field Boundary

If you go outside the field boundary but are still within the treatment rectangle, a  icon flashes on the display and the instrument beeps continuously. The application rate reverts to the base rate.

If you are outside the field boundary and treatment rectangle, then the application rate goes to zero.

3.2.2 Overriding the VRT application rate

You can vary the actual application rate at any time using the   keys.

The target rate display will flash until you press  to return to the target rate.

3.2.3 Stop a VRT job

To stop running a job, simply press the "STOP" key on the LOG screen. The job summary is appended to the work record file on the data module, and saved to the internal memory.

3.2.4 Tagging

During application, you can log the presence of up to eight different features in the field, e.g. different weed infestations, pest damage etc. To switch a tag on or off, simply press the appropriate number key.



-  indicates a tag is off
-  indicates a tag is on

Figure 17
Setting Tags



Tags 1 to 4 are preset for Blackgrass, Wild Oats, Cleavers and Thistles. You can however, edit the tag names from the "GENERAL PF SETUP" menu.

3.2.5 Extended Data Functions

Dynamic log files and simple job summaries can include up to 12 additional data. All 12 data items can be user-defined to suit individual requirements e.g. Operator name, Wind Speed, Air Temperature, Growth Stage, Product etc.

Entering extended data is optional.

Figure 18
Setting Extended Functions



The functions are "F1" to "F12" by default. You can re-programme the default function names and function values from the "GENERAL PF SETUP" menu (please refer to the calibration manual). If you do not want to change the default, simply press  to accept it, and then the next "F" function appears (fig. 18).

Enter the data (up to 20 alpha-numeric characters) via the alpha-numeric keypad. The existing data will be over-typed. Press  to confirm the data entry.

You can repeat the data entry procedure for up to 12 'F' functions, however, if you do not need to programme any of them, simply press  at any time to start logging.

3.2.6 Display vehicle track - "MAP"

From the LOG screen (fig. 15), press the "MAP" key.

The screen displays the real time position of the vehicle (the "+" cursor), and the vehicle track for the last 100 logged data points.

The screen also displays the latitude and longitude in decimal degrees, and the number of points. As the vehicle proceeds from the start of the job, the screen plots and automatically zooms out to display up to a maximum of 100 logged data points. Beyond this, as the job progresses, the display pans in the direction of movement to keep the previous 100 data points on screen.

Press the 'RESET' key to start the plot again from the current position.

Figure 19
Displaying the vehicle track



If you selected the "LOG TREATMENT" option from the LOG screen page, the track data is saved to a dynamic logging file on the data module, which can then be viewed in PLOT/PLAN.

3.2.7 Display GPS Status

From either the LOG page, "RUNNING TREATMENT PLAN" page or "RECORDING A DYNAMIC JOB" page, press the  key to view the current GPS status.

Figure 20
GPS Status



This page displays;

Age of Fix Data (when reception is good, the time should not be more than 1 second); Number of Satellites (minimum of 4 for full differential fix); Differential Status; Latitude and Longitude (in decimal degrees); Altitude; Heading and Velocity.

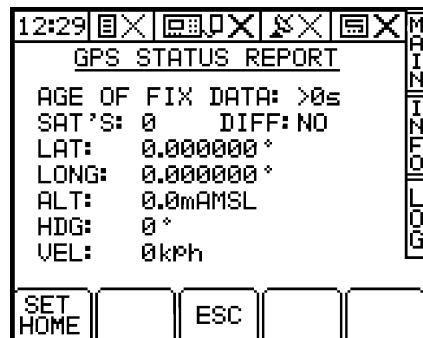
All this data is read directly from the NMEA GGA and VTG messages. You can also set the "Home Position" from this screen (for a full explanation of "Home Position", please refer to the calibration manual).

3.3 Dynamic Data Logging

When spreading conventionally (i.e. not VRT mode), you have an option to generate an application record, logging rate and other parameters (e.g. "tags") in real time, attributing this data to a specific location. The associated "Dynamic Logging" file is saved onto the Data Card Module and can subsequently be viewed in PLOT/PLAN.

An RDS Data Card Module and a GPS receiver must be connected.

3.3.1 Start recording a Dynamic Job

- 1 Press the LOG key.

The screen will display the current logging status, the number of jobs (job summaries) stored in memory, and the status of the PCMCIA card if found (fig. 14). If the module is not detected the message "NO MODULE FOUND" is displayed. When successfully connected, the  icon appears at the top of the screen.

- 2 Press the START key. The JOB STARTUP page is displayed (fig.14)
- 3 Select the logging option "LOG TREATMENT".
- 4 When prompted, enter the FARM NUMBER and FIELD NUMBER reference. The "EXTENDED DATA FUNCTIONS" page is then displayed. If you don't wish to programme any extended functions. then press  .
- 5 If you want to programme extended functions, refer to section 3.2.5.

The screen will display "NEGOTIATING FILE STORAGE - JOB NUMBER #" as it creates the dynamic log file on the data module. Once the plan is loaded, the "RECORDING A DYNAMIC JOB" page appears, and displays the tag list (fig. 21).

Figure 21
Dynamic Logging



While dynamic logging is in progress, the  icon appears animated at the top of the screen.

- 6 You can at any time apply the Tag functions to log features in the field. Please refer to section 3.2.4 overleaf.



NOTE:

If more than one machine is enabled, the summary job record will include data for each machine.

3.3.2 Stop recording a Dynamic Job

To stop running a job, simply press the "STOP" key on the LOG screen. The job summary is appended to the dynamic log file on the data module, and saved to the internal memory.

3.4 Field Data Logging

For farm record keeping and traceability purposes, you can record a summary of each job or work session in the internal memory, and subsequently download directly to a PC, or print to an RDS ICP200 In-Cab Printer. You can store up to 75 job summaries.

3.4.1 Start recording Field Data

- 1 Press the LOG key.

The screen will display the current logging status, the number of jobs (job summaries) stored in memory, and the status of the PCMCIA card if found (fig.14).

- 2 Press the START key. The JOB STARTUP page is displayed (fig.14).

- 3 Select the logging option "LOG SUMMARY ONLY".

- 4 When prompted, enter the FARM NUMBER and FIELD NUMBER reference. The "EXTENDED DATA FUNCTIONS" page is then displayed. If you don't wish to programme any extended functions, then press  .

- 5 If you want to programme extended functions, refer to section 3.2.5.

The "RECORDING A JOB SUMMARY" page appears (fig. 22). While field data logging is in progress, the  icon appears animated at the top of the screen.

Figure 22
Field Data Logging



NOTE: If more than one machine is enabled, the summary job record will include data for each machine.

3.4.2 Stop recording Field Data

To stop running a job, simply press the "STOP" key on the LOG screen. The job summary is saved to the internal memory.

3.5 Review, Reset or Download a Job Summary

You can view, delete, print or download the job summaries. The summary prints out as a job ticket and includes space for comments and signature. It includes all the basic data listed in section 3.5.2 along with any extended data that was programmed, for each tank that is enabled.

3.5.1 Review / Reset Job Summaries

- 1 Press the  key from the LOG page.

Figure 23
Review / Reset Job Summaries



- 2 Scroll through the individual summaries using the arrow keys.
- 3 Press the **RESET** key to delete the selected summary.

3.5.2 Summary Data Formats

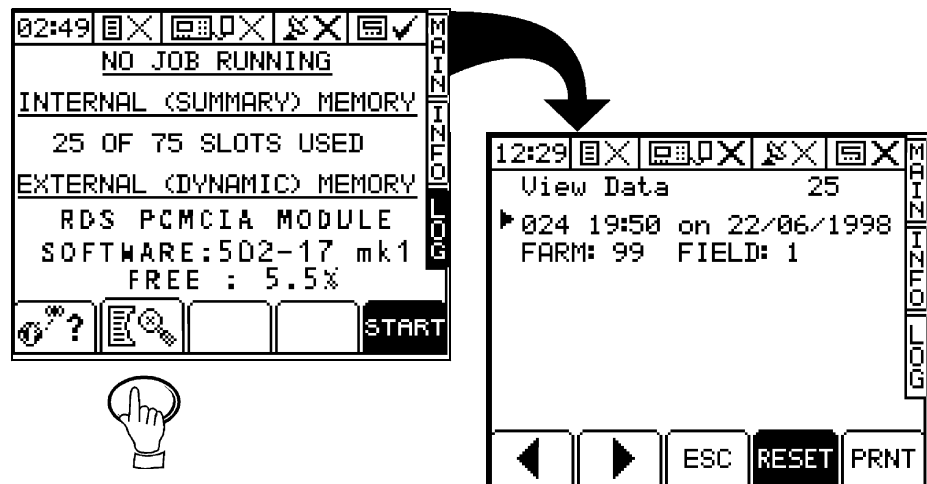
You can download the data to;

Data Card Module - Each summary is saved as a text file e.g. "JOB0001.TXT", and is formatted the same as a printed job ticket.

ICP 100 or ICP 200 In-Cab Printer - prints in .TXT format as a job ticket with space for written comments and a signature.

Directly onto a PC - via the "Pro-Series PC Upload Lead" ref: RDS Pt. No. S/CB/268-1-032. Data can be output in .CSV format for import into a spreadsheet or database.

The top port should be configured as follows;

Data Card Module - "RDS PF MODULE"

ICP 100 In-Cab Printer - "RDS PRINTER TYPE I"

ICP 200 In-Cab Printer - "RDS PRINTER TYPE II"

Directly onto a PC - "PC DOWNLOAD"

Job summaries from the Apollo controller contains the following data;

- Job Number
- Start Date
- Start Time
- End Time
- Job Duration
- Channel No.
- Machine ID / Name
- Farm No.
- Field No.
- Product / Crop
- Cal Factor
- Area
- Work Rate
- Quantity spread
- Quantity loaded
- Average Application Rate
- Extended Functions F1 to F12 values

- Comments*
- Operator*
- Transmit Time and Date

* Not included in .CSV format

3.5.3 Select and Print / Download Job Summaries

- 1 From the "View Data" page (fig. 23, 24), press the **PRNT** key.

Figure 24
Download Job Summaries

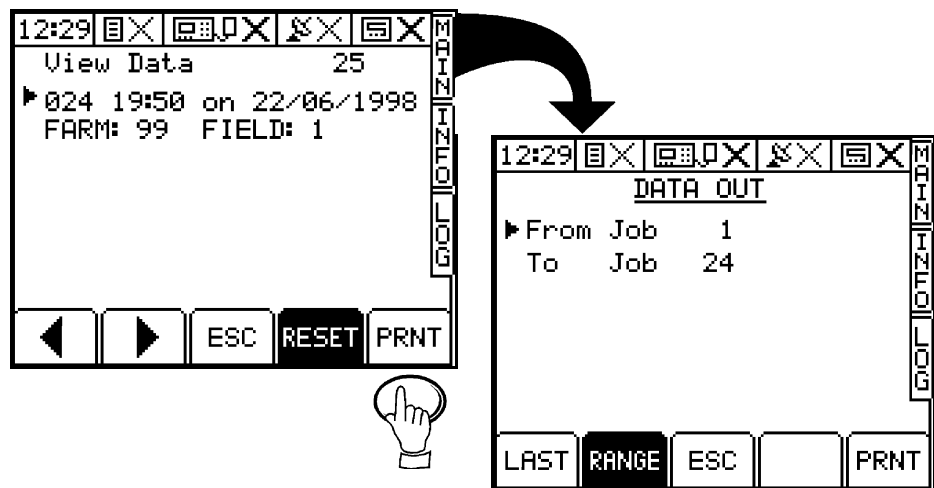

- 2 Press **LAST** to select the last summary recorded or press **RANGE** to select a number of individual summaries.
- 3 If downloading a range of job summaries, simply type the job numbers on the "DATA OUT" page, then press **PRNT**.
- 4 Select the printout style:- TEXT MODE for ASCII text output or CSV MODE for import into an Excel spreadsheet.

Issue 1 : 20/9/01

For Software Issue PS516-000 rev.30 Previous manual was S/DC/500-10-223 issue 1 covering S/W Issue PS504-019.